

# Architectural Door Accessories

**ASSA ABLOY**

## Rockwood 596 Series Push/Pull Latch

The global leader in  
door opening solutions

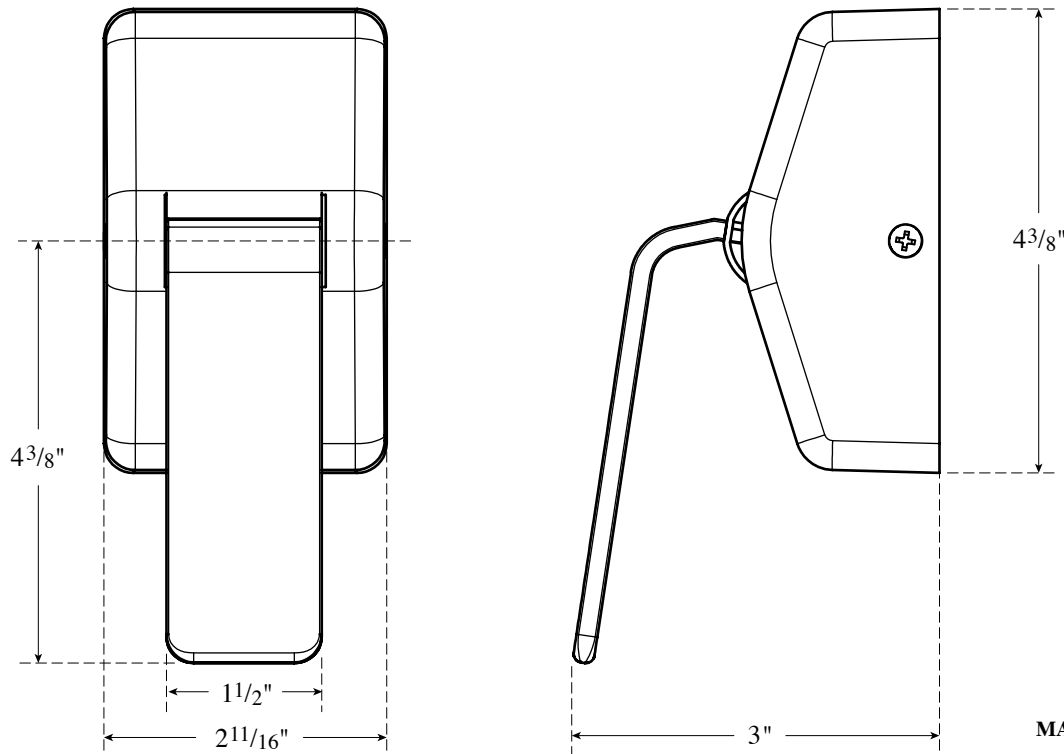

### Template T-596

**Effective date:** January 1, 2017  
**Supersedes:** All Previous

NOTE: ASSA ABLOY reserves the right to make product changes and is not responsible for obsolete template errors. To ensure your template is current, please visit our website at [www.rockwoodmfg.com](http://www.rockwoodmfg.com) or call us at 800-458-2424

**MATERIAL:** Stainless Steel

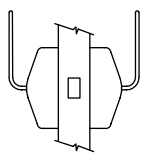

**LEVERS  
UP**

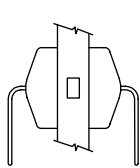

**LEVERS  
DOWN**

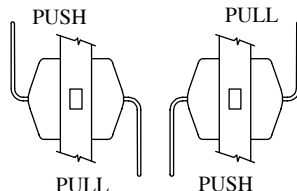

**LEVERS  
MIXED**

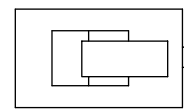

**LEVERS  
HORIZONTAL  
WITH 7"  
BACKSET**

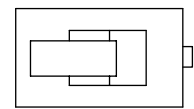

**LEVERS  
HORIZONTAL  
WITH 5" OR 7"  
BACKSET**

**FASTENERS NOTE:** (two) #8 x 3/4" Combination Screws; (four) 1/4"-20 x 2 1/2" Pan Head Machine Screws  
(four) 1/4"-20 Hex Lock Nuts; (four) #8-32 x 3/8" Flat Head Machine Screws

#### **NOTES**

1. Trim can be Mounted Up, Down, Horizontally or Vertical or in any Combination.
2. Uses Standard 161 Door Prep.
3. Vision Lite must be at Least 6" from Latch Prep.

#### **OPTIONS**

- Engraved "PUSH" or "PULL"
- Lead lined



PATENT No.6, 196,599

300 Main Street  
Rockwood, Pennsylvania 15557  
P: 800.458.2424 | F: 800.922.9212  
[www.rockwoodmfg.com](http://www.rockwoodmfg.com) | [orders.rockwood@assaabloy.com](mailto:orders.rockwood@assaabloy.com)

Copyright © 2017, Rockwood Manufacturing Company, an ASSA ABLOY Group company. All rights reserved.  
Reproduction in whole or in part without the express written permission of Rockwood Manufacturing Company is prohibited.

# Rockwood 596 Series Push/Pull Latch (cont.)

NOT TO SCALE

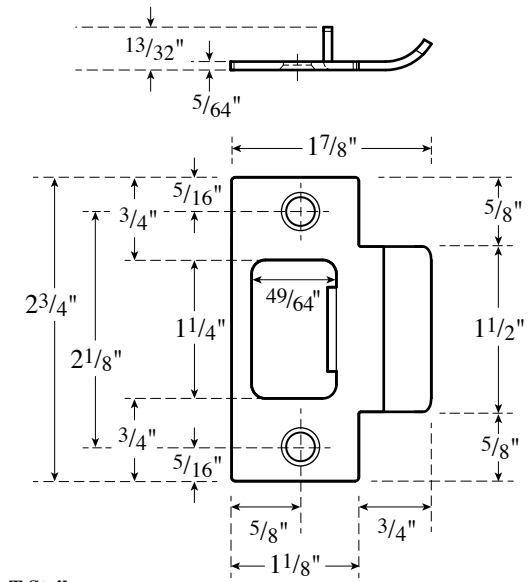

T Strike

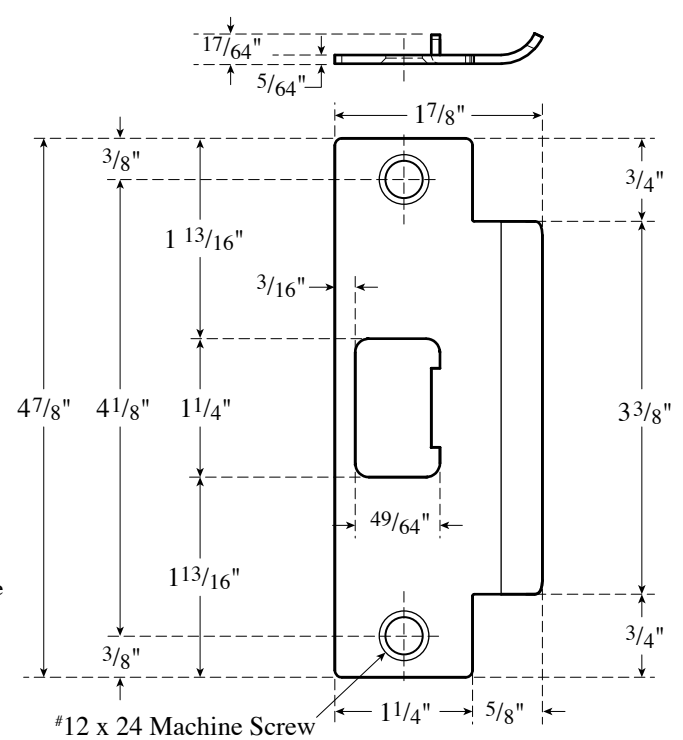

ASA Strike

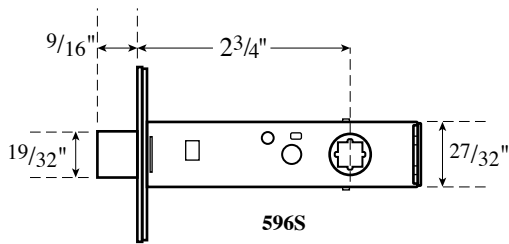

596S

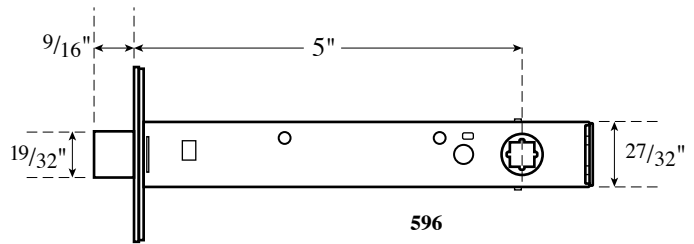

596

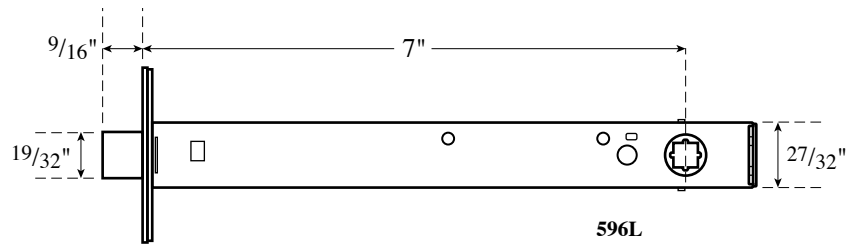
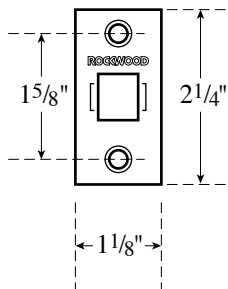

596L

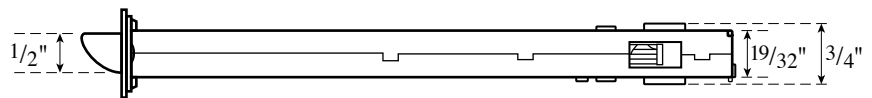

# Rockwood 596 Series Push/Pull Latch (cont.)

**NOT TO SCALE**  
For dimensional use only

**ATTENTION:**

If smoke seal, weather stripping, acoustical material or silencers are used on the door or frame, be sure that they do not interfere with the ease in which the latch bolt engages into the strike.

**CAUTION:**

Office copiers, printers and facsimile machines may change the size of a drawing and make the template inaccurate to use as a door marker.

1. Select required backset: 2<sup>3</sup>/<sub>4</sub>", 5", or 7".
2. Fold on dashed line.
3. Place fold on low edge of bevel.
4. Line up centerlines.
5. Center punch all holes.
6. Drill holes. (For hollow metal doors, do not drill thru. Center punch & drill holes from both sides of door.)

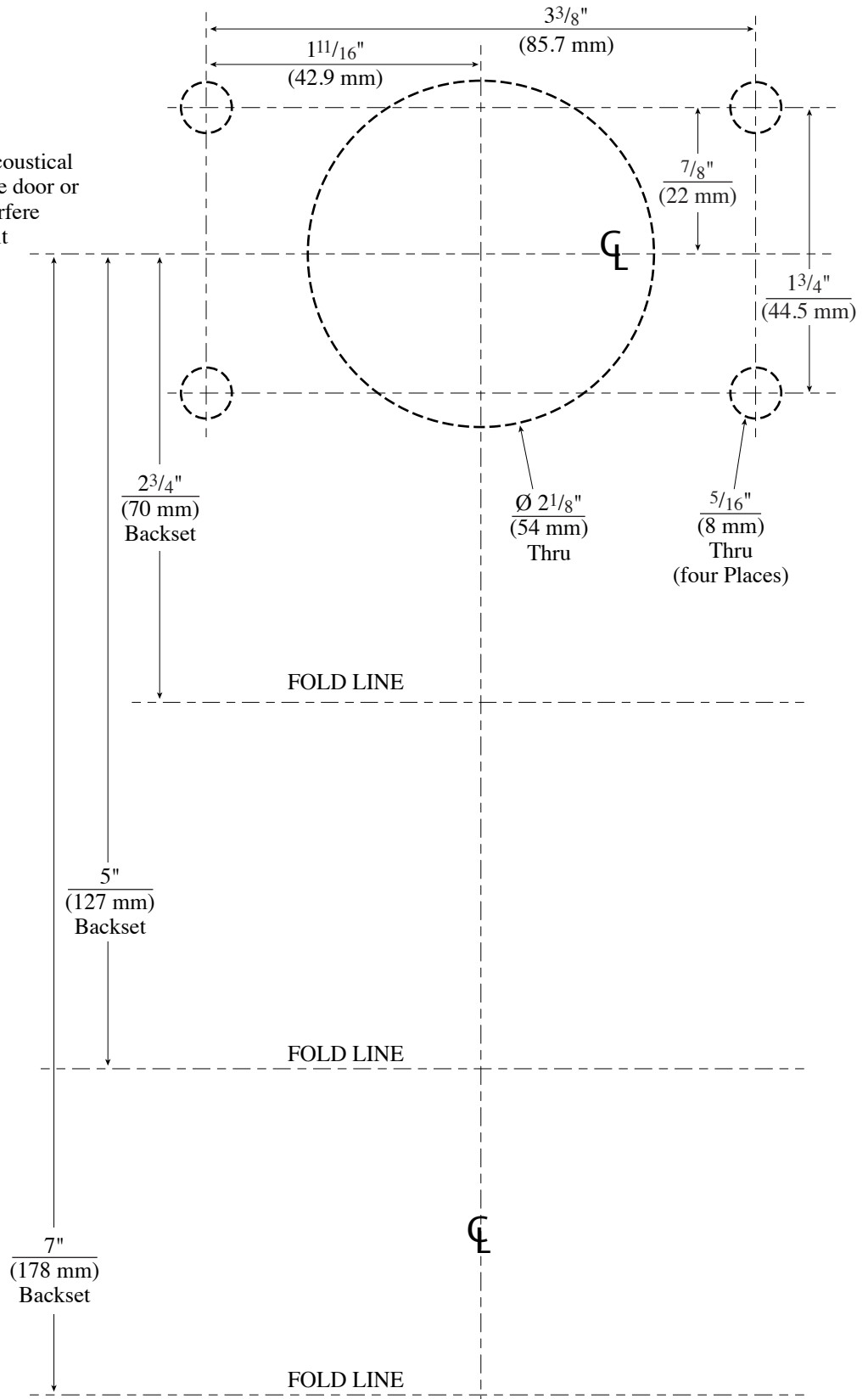

ASSA ABLOY is the global leader in door opening solutions, dedicated to satisfying end-user needs for security, safety and convenience

---

**ASSA ABLOY**